

CITY CRANE MD 125 B

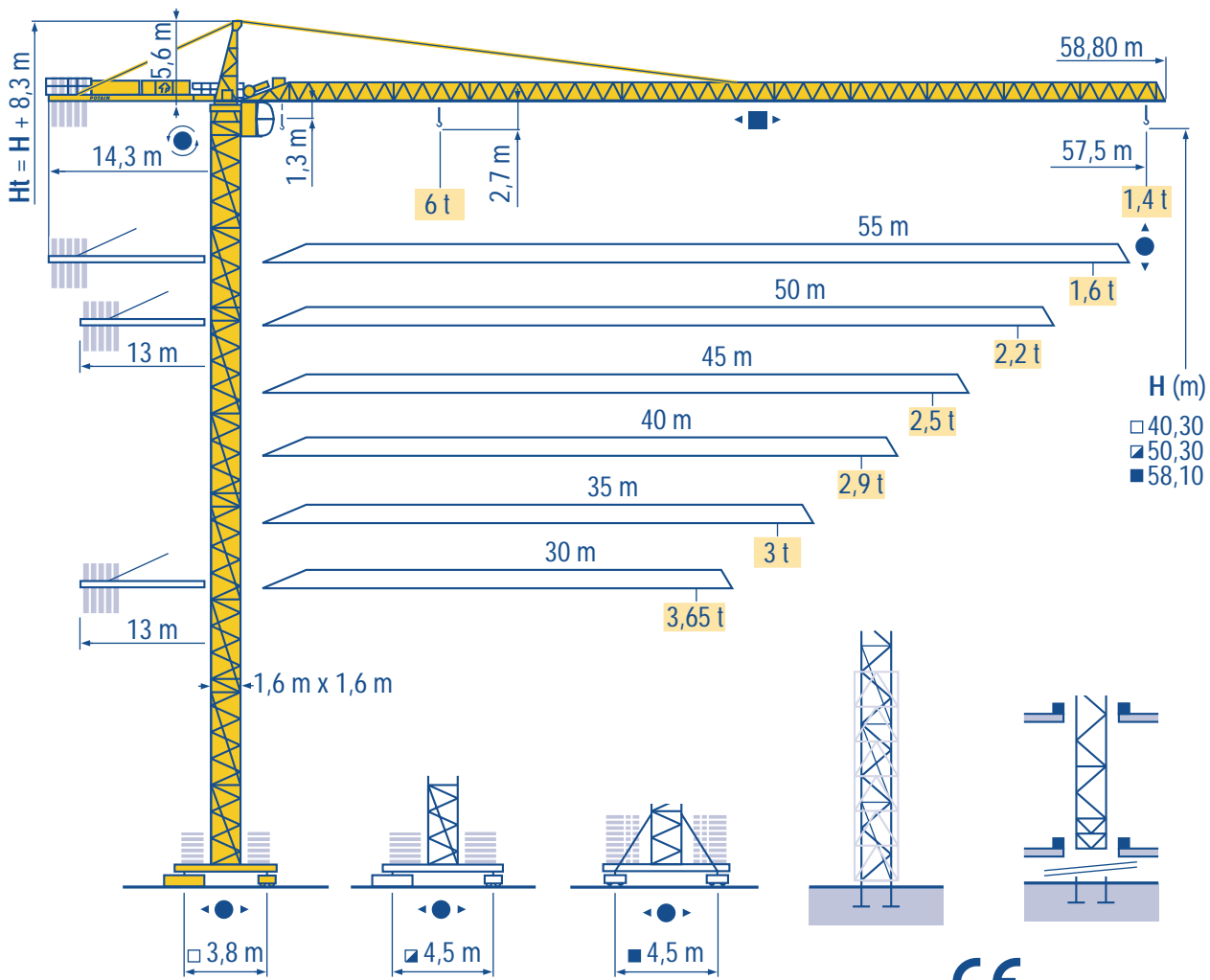

HD
HDM



HDT



GTMR



CITY CRANE



TOPKIT MD
MAXI MD



MAXI TOPKIT



Topless MDT



MR



CE FEM 1.001-A3



Mat / Réactions
Maste / Eckdrücke
 City 1,6 m

F **Masts / Reactions**
D **Mástil / Reacciones**
 City 1,6 m

GB **Tower / Reazioni**
E **塔身/反力**
 City 1,6 m

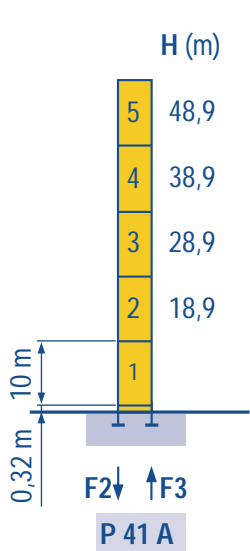

F2	● 105 t	■ 147 t
F3	● 71 t	■ 116 t
	33 t	

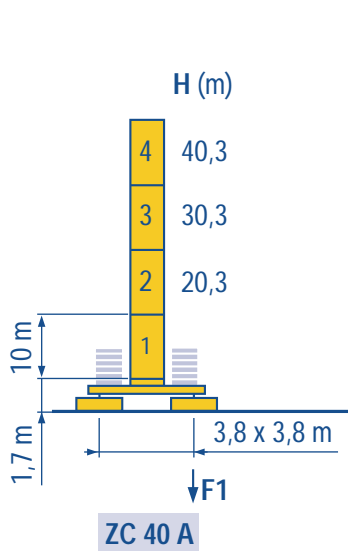

F1	● 58 t	■ 63 t
	35 t	

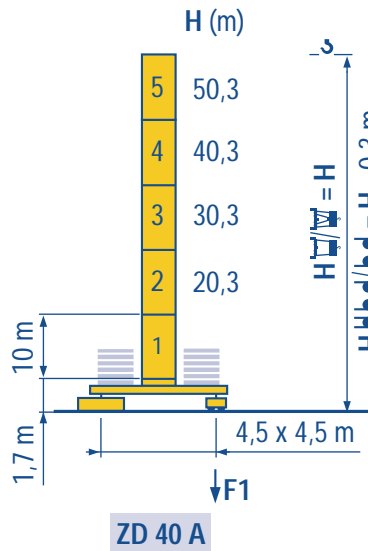

F1	● 65 t	■ 83 t
	40 t	

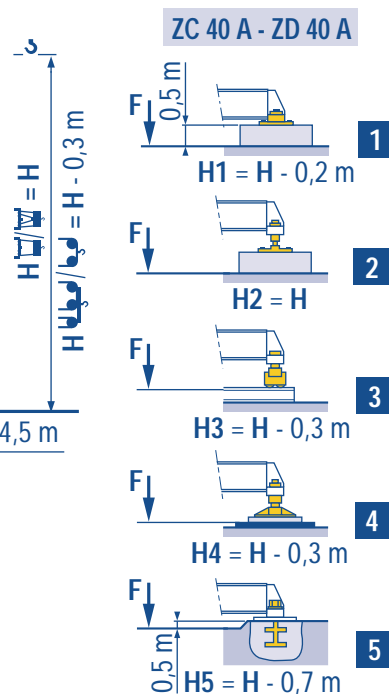

F **Télescopable 1,6 m**
D **Teleskopierbar 1,6 m**

GB **Telescopic 1,6 m**
E **Telescopico 1,6 m**

I **Telescopico 1,6 m**
C **可顶升 1,6 m**

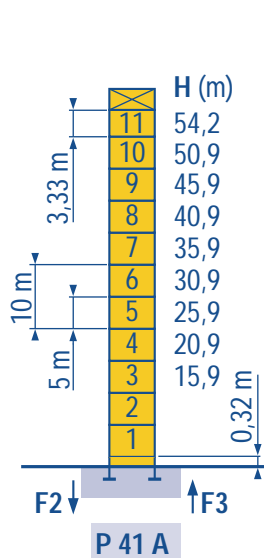

F2	● 115 t	■ 173 t
F3	● 81 t	■ 142 t
	46 t	

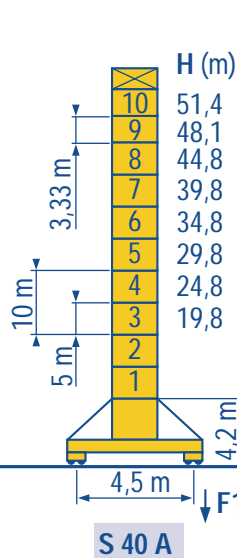

F1	● 73 t	■ 96 t
	50 t	

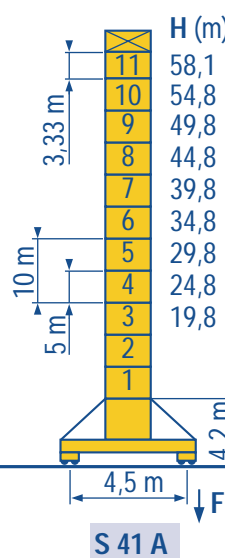

F1	● 86 t	■ 121 t
	54 t	

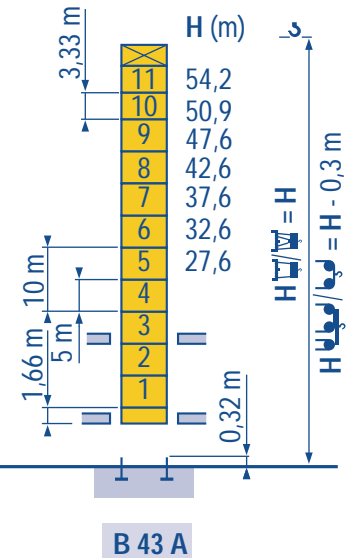

F Voir télescopage sur dalles
 ● Réactions en service
 ■ Réactions hors service
 A vide sans lest (ni train de transport) avec fleche et hauteur maximum.

D See climbing crane
 Reactions in service
 Reactions out of service
 Without load, ballast (or transport axes), with maximum jib and maximum height.

GB Consultare gru in cavedio
 Reazioni in servizio
 Reazioni fuori servizio
 A vuoto, senza zavorra (ne assali di trasporto) con braccio massimo e altezza massima.

E Siehe kletterkrane im gebäude
 ● Reaktionskräfte in Betrieb
 ■ Reaktionskräfte außer Betrieb
 Ohne Last, Ballast (und Transportachse), mit Maximalausleger und Maximalhöhe.

E Vea grua trepadora
 Reacciones en servicio
 Reacciones fuera de servicio
 Sin carga, sin lastre, (ni tren de transporte), flecha y altura máxima.

C 見楼板顶升
 工作状态下的反应
 非工作状态下的反应
 空载无压重也无运输车有吊臂和最大高度

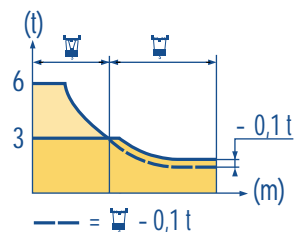
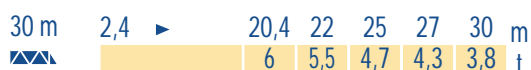
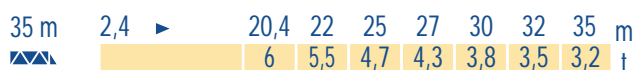
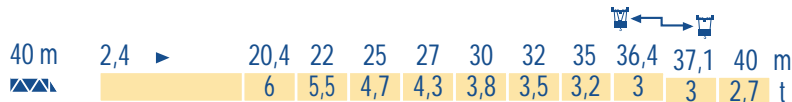
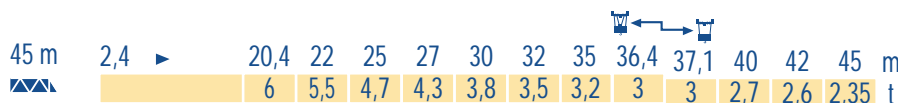
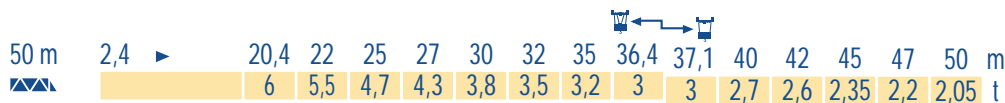
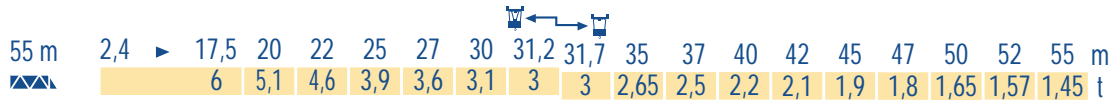
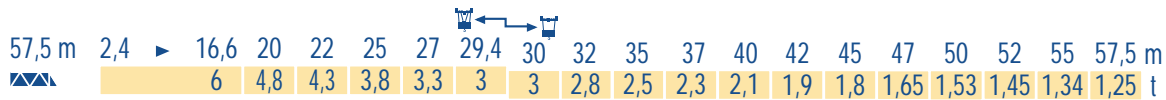
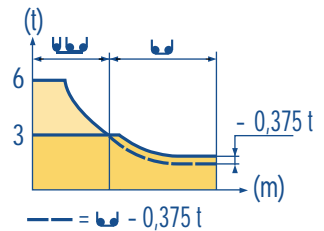
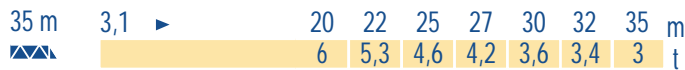
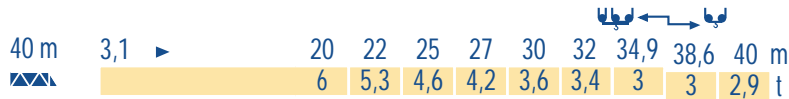
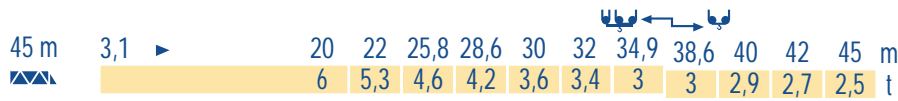
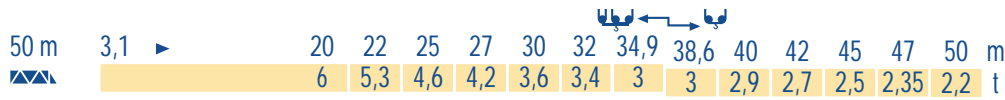
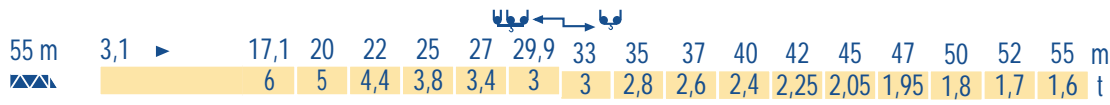
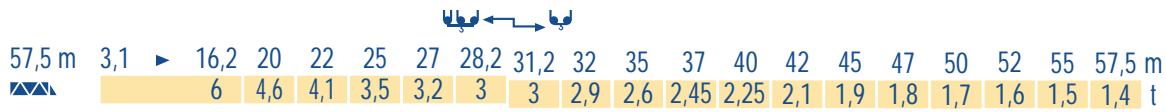

LSP 1

B 43 A

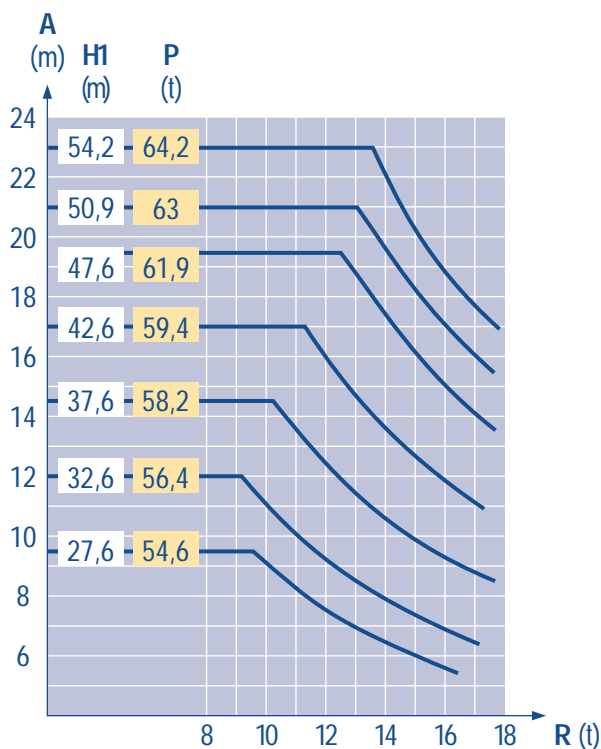
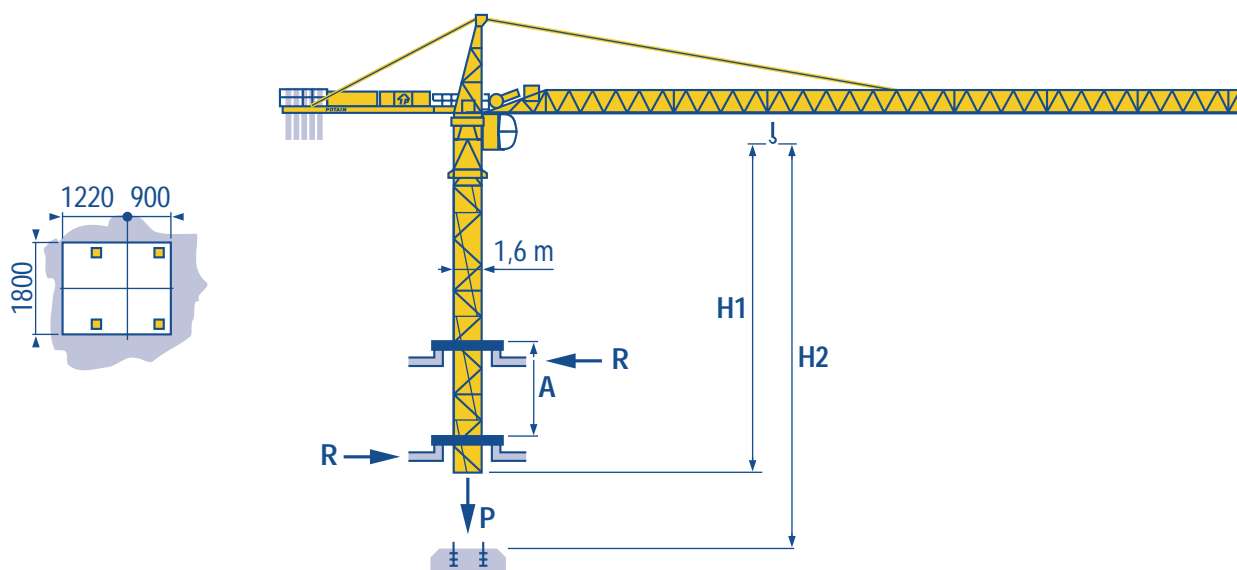

LSP 1

A Distance entre cadres

F

Distance between collars

GB

Distanza fra i telai

I

H1 Hauteur grue

Crane height

Altezza gru

P Poids de la grue (en service)

Crane weight (in service)

Peso della gru (in servizio)

R Réaction horizontale

Horizontal reaction

Reazione orizzontale

A Abstand zwischen den Rahmen

D

Distancia entra marcos

E

各附着框之间距离

C

H1 Kranhöhe

Altura grúa

工作状态下塔机高度

P Krangewicht (in Betrieb)

Peso de la grúa (en servicio)

工作状态下塔机重量

R Horizontalkräfte

Reaccion horizontal

水平反力

Lest de contre-flèche
Gegenauslegerballast



Counter-jib ballast
Lastre de contra flecha



Contrappeso
平衡臂重



		3450 kg	2250 kg	 (kg)
57,5 m	14,3 m	5	-	17 250
55 m	14,3 m	4	1	16 050
50 m	13 m	4	1	16 050
45 m	13 m	3	2	14 850
40 m	13 m	4	-	13 800
35 m	13 m	3	1	12 600
30 m	13 m	2	2	11 400

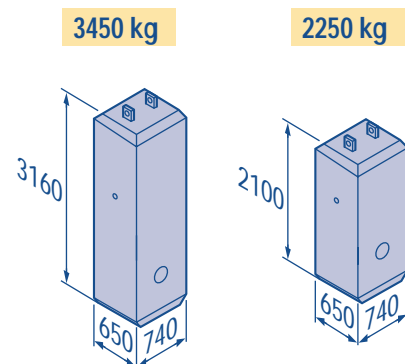

LSP 1

Lest de base
Grundballast







Base ballast
Lastre de base











Zavorra di base
压重





∅1,6 m	ZC 40 A - ● >	H (m)	40,3	30,3	20,3						
		 (t)	65	60	55						
∅1,6 m	ZD 40 A - ● >	H (m)	50,3	40,3	30,3	20,3					
		 (t)	70	55	45	45					
∅1,6 m	S 40 A - ● >	H (m)	51,4	48,1	44,8	39,8	34,8	29,8	24,8	19,8	
		 (t)	84	72	54	36	36	36	36	36	
∅1,6 m	S 41 A - ● >	H (m)	58,1	54,8	49,8	44,8	39,8	34,8	29,8	24,8	19,8
		 (t)	114	102	78	54	36	36	36	36	36

LSP 1

		U ↑			UU ↑			ch - PS hp	kW		
	25 PC 15	m/min	6	30	60	3	15	30	25	18,4	260 m
		t	3	3	1,5	6	6	3			
	33 PC 15	m/min	6	37,5	75	3	19	37,5	33	24	260 m
		t	3	3	1,5	6	6	3			
	33 LVF 15 Optima	m/min	3 → 12 → 36 → 48 → 68 → 92	1,5 → 6 → 18 → 24 → 34 → 46			30	22	260 m		
		t	3 3 3 2,25 1,5 0,75	6 6 6 4,5 3 1,5							
	50 LVF 15 Optima	m/min	5 → 20 → 62 → 80 → 114 → 150	2,5 → 10 → 31 → 40 → 57 → 75			50	37	398 m		
		t	3 3 3 2,25 1,5 0,75	6 6 6 4,5 3 1,5							
	4 D3 V3	m/min	15 - 30 - 58						4	3	
	RCV 145	tr/min U/min rpm	0 → 0,8						2 x 6	2 x 4,4	
ZC 40 A ZD 40 A 	RT 224	m/min	25						2 x 4	2 x 2,9	
S 40 A 	RT 324 R ≥ 10 m	m/min	12,5 - 25						2 x 7	2 x 5,2	
S 41 A 	RT 443 A1 2V R ≥ 10 m	m/min	15 - 30						4 x 5	4 x 3,7	

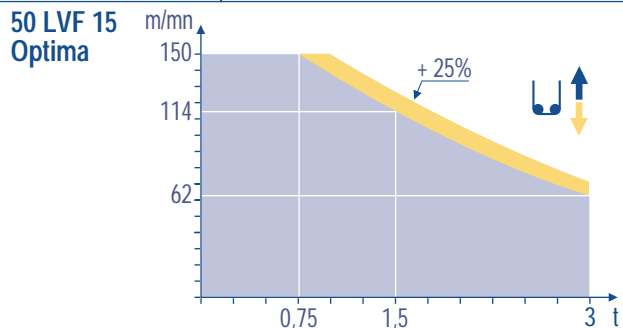
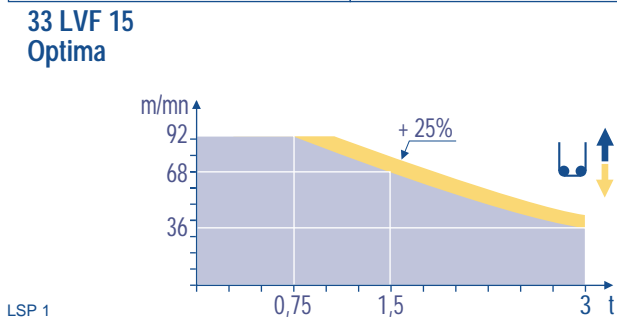
CEI 38 	IEC 38	kVA	
400 V (+6% -10%) 50 Hz		25 PC : 40 kVA 33 PC : 50 kVA 33 LVF : 50 kVA 50 LVF : 65 kVA	84/534 - 87/405



	Levage Distribution Orientation Translation Conforme aux directives CEE 84/534 et 87/405 sur le niveau acoustique	F	Hoisting Trolleying Slewing Travelling In compliance with the EEC 84/534 and 87/405 Instructions on noise level	GB	Sollevamento Distribuzione Rotazione Traslazione Conforme alle direttive CEE 84/534 e 87/405 sul livello acustico	I
	Heben Katzfahren Schwenken Kranfahren Gemäss EWG-Richtlinien 84/534 und 87/405 für den Schall-Leistungspegel	D	Elevación Distribución Orientación Traslación Conforme con las directivas CEE 84/534 y 87/405 sobre el nivel acustico	E	起升 变幅 回转 行走 符合 CEE 84/534 - CEE 87/405 声晌度规定	C

Ref. 2000.05 LSP 1



18.Rue de Charbonnières, B.P. 173
F-69132 ECULLY Cedex
Tél. (33)04.72.18.20.20
Fax (33)04.72.18.20.00
http://www.potain.com
E-mail : mkt@potain.fr

CITY CRANE MD 125 B
Copyright.Reproduction interdite © POTAIN 2000

Deutschland
POTAIN GmbH Tel : 06.105.704.0
Italia
POTAIN S.p.A. Tel : 0.331.49.33.11
Singapore
POTAIN PTE LTD Tel : (00.65) 227.1550